



Switch[®]
Bowling with style

Switch®

A whole new environment
of style, sport and speed

There's a new idea behind Switch®
bowling. It's based on speed,
sport and style. The best-known name
in Italian industrial design and the most
advanced bowling technology have come
together to create a whole new, exciting
environment for entertainment...
from seating and ball racks to lanes,
lighting and electronic scoring.
It is an eye-opening environment,
designed to bring more quality and more
performance to bowling.
There's a new world of style, speed and
sport waiting for you. It pays to discover it.
Bowl with style. Bowl with Switch®.

Switch®

How years of experience have changed every component of bowling

An understanding of consumer trends and the importance of the physical configuration of equipment

Bowling has moved into the 21st century with more force than a speeding ball. The force propelling it is a company called Switch®, created by people with years of experience in both bowling and leisure. The company's wide-ranging know-how begins with original and practical design and state-of-the-art manufacturing and continues right through to marketing, sales and installation... including customer service and operations worldwide.

What's making Switch® click? Its well-known partners: Pininfarina, Toshiba and Abet Laminati. They are all highly respected world leaders in their fields, with totally new ideas that are making bowling more fun, more exciting and more welcoming to new enthusiasts.

Their visionary concepts are opening one of the fastest growing leisure activity markets even further. In fact, they are so passionate about Switch®, they have lent their brand names to the equipment they designed and created.

Pininfarina, renowned for its Ferrari and Maserati automotive design and a wide range of industrial design concepts, works closely with Switch® to create bowling facilities that not only look different, but are different.

Pininfarina designers are well known for their understanding of consumer trends and the importance of the physical configuration of equipment... key to the whole philosophy and spirit of Switch®.

The innovative line of products brings new standards of functionality and design to the bowling environment, giving flexibility to the layout possibilities and an excellent balance of style and performance to the user.

Paolo Pininfarina, C.E.O. of Pininfarina Extra:
"Pininfarina has always paid close attention to designing sports equipment. We enthusiastically support this project in the bowling sector, one of the most enjoyable sport games."

www.pininfarinaextra.it

Certifications and memberships:

The Switch® Capital Equipment package is delivered with a European Certificate of Origin. The equipment is also CE approved, GS-certified by the German Labour Safety Organisation and USBC approved. In addition, Switch® has FIRA/UL certification, a fire safety certification for plastic and polyurethane objects.

Switch® is also a member of the EBPA and the ICSC.



Switch[®] 2,
the scoring
system
revolution
is here

The Switch[®] Front Desk, with its refined, high-tech 'operator main screen', will be warmly welcomed by bowling centre operators. The control panel, which operators will be using for hours each day, has a clean and sophisticated look. Since each screen functions independently and has a unique size and on-screen position, it is also easy to use.



Custom preferences

All custom preferences can be easily added, modified and saved with the Switch® preference screen. The people behind Switch® have learned from 30 years of worldwide experience that every centre must be configured in a unique way. It has been a goal at Switch® to make this easy-to-use system available. Now, navigating through many features can be done with little to no effort.

At Switch®, we put experience to work.

Payment methods that pay

Switch® offers a wide range of payment methods, such as pay per game, per hour, post-pay or pre-pay mode. The numerous rate possibilities, whether or not they are discounted, are all easily configured. This is tied-in with the unique bowler's archive, since every bowler entered in the archive is automatically detected by the system. The system will also allocate a pre-defined rate to the bowler. Also included is a loyalty programme, defined by the number of games bowled. The Switch® system automatically keeps track of all activity... a great marketing tool.

Food for thought

Food and beverage sales are easily handled by the Switch® system, whether selling items to lane accounts or over the counter. Bowlers can even order specific food and drinks directly from the bowler console. All product images can be imported from any computer or even captured by the main desk webcam. This handy Switch® system will certainly help raise in-house sales. Profit from Switch®.



Handy 'user groups'

To operate the system, each operator must 'check in'. There are two ways to do this, either by a very fast swipe of the operator's magnetic card or entry of a personal password. The card gives each operator associated to their photo a number of security levels - set by the owner or manager - at which they are allowed to operate. To facilitate this procedure, the Switch® system generates 'user groups', placing operators with similar security levels into groups, such as manager, assistant, cashier and mechanic.

Unique bowler's archive

The Switch® bowler's archive is a one of a kind feature. In just a few seconds, bowling centres can capture photos and complete bowlers' details. The system automatically recognises bowlers each time they bowl and logs all their activities; money spent, games bowled, scores and averages. The Switch® bowler's archive provides the highest degree of detail, even storing splits left and picked up and whether spares are closed or not.



A booking genius

Easy-to-use, practically paper-free Switch® advanced booking, using colour-coded bookings, shows at a glance which lanes and times have been booked. Operators can take credit card deposits over the phone and the Switch® scoring system will apply the deposit to the account when needed. Operators can also track and trace every activity, book multiple lanes for groups and pre-enter names to save time when they are due to play. A great time saver.



Name your theme

Switch® has an impressive number of on-lane themes and a variation of images. The system makes it easy to set up themes into groups, including or excluding any images. For special events, a theme can be made readily available so no time is wasted. There are themes to suit every taste, from Halloween and Wild West to car races on ice. At Switch®, creative ideas are always on the move.



With Switch®,
bowling centres
can now ensure
the very best
service to bowlers

Name your game. Switch® handles it.

The centre's non-bowling activities, such as billiards, darts, laser tag, table tennis and foosball are managed with extreme simplicity and refined imaging. With Switch®, any game or activity on offer is customised. Detailed reports of use and time management are available at any time.



Speed is a way of life.

Switch® bowler console commands are the clearest, most flexible and easiest to use in the industry. Bowlers no longer waste time with long lists of functions. Now, simple commands grouped into specific areas give bowlers more enjoyable game time. They can also place bar and snack bar orders, change a line up, correct a score or even select a preferred theme to show on lane monitors.

Smile, you're on camera.

On busy weekend nights, the Switch® electronic waiting list not only accelerates the handling of customers, it provides an ideal time to take bowlers' pictures and add them to the archive. In just seconds, the Switch® integrated webcam allows operators to take a picture and insert all the relevant data. With Switch®, speed is a way of life.



Automatic upgrades

The Switch® hardware platform comprises the most advanced technology, permitting years of unlimited updates. Software updates are regularly made available online. There's no need for difficult upgrade procedures. With Switch®, it's all done automatically, naturally.



Switch® and the “wow effect”

Switch® high-resolution animations and graphics can be viewed on our quality 32” LCD monitors customised for Switch®. For a wow effect, there is an optional 42” LCD monitor of exceptional quality.



Console

Pininfarina has specially designed the Switch® bowlers' console, featuring a flat panel, special thermo-treated touch screen keyboard... as an option, you can choose a state-of-the-art 15” LCD touch screen.

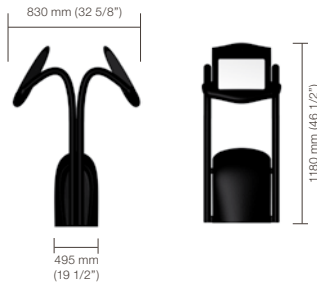

Switch[®] equipment.
Now that's style!

In the true Pininfarina design spirit...
tables, benches and ball racks that are
stylish, sturdy and functional.
NEW! Switch[®] equipment in dazzling
colours. Red, metallic and yellow.



Look for the 'S'
on the hood and rack

The Switch® hood and rack, designed by Pininfarina, with its distinctive 'S'. The elegant tubular frame provides strength and durability. The lower rack is as easy to install as a clip-on component. Fan and reset buttons are conveniently located inside the solid high quality compact polyurethane. Access to the power lift and maintenance area is easy and requires no special tooling.

The Switch® "S" ball return is mounted on a special approach panel fitted with a synthetic sleeve to permit branding and promotion of the approach area. This gives the bowling centre's proprietor an easy and attractive way to generate additional revenue.



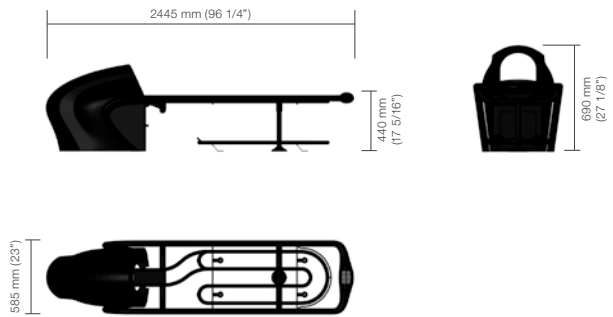

Exciting new
stylish colours



The art of seating... Pininfarina style

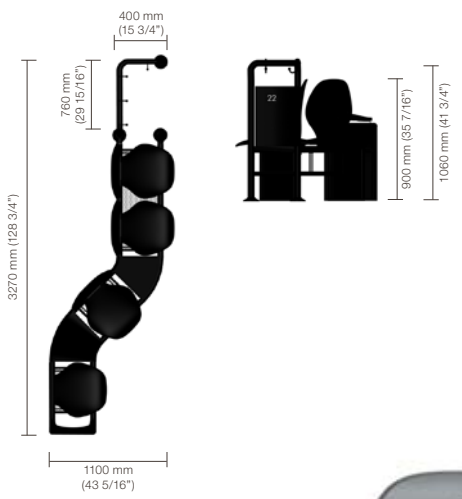
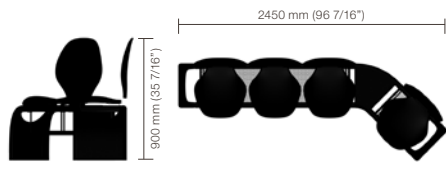

Switch® puts the spotlight on Pininfarina design with highly advanced seating arrangements. There are even slightly elevated seats for bowlers waiting their turn. Sturdy shoe racks under the seating eliminate the clutter of shoes on the floor. Coats? Bowlers can hang them up on the Switch® coat racks where they are sitting.

The seating's tubular frame is made of robust metal specially treated for strength and resistance to rust. All connecting joints and legs are made of high-quality compact Polyurethane, painted using the latest robot technology.

The Switch® signature seating is the Pininfarina straight-line arrangement. However, the seating arrangements can be installed in a variety of configurations. Conventional, horseshoe and straight-line configurations are easily rearranged, much like a "Lego®" system.

The seating is available in three colours: red, yellow and metallic. In the metallic colour version, the entire seat is glow in the dark, giving an exciting and attractive look to a centre when they switch to a party mood.





Ball rack

The Switch® ball rack is stable and pleasing to the eye. It stores 12 bowling balls, making them easily accessible to bowlers.

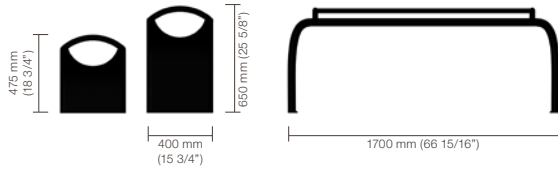

Bench

The Switch® bench, with a tubular frame and polyurethane legs, offers maximum stability. The benches are available in low and high models.

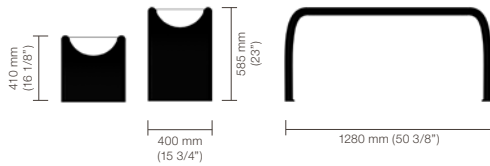

Cocktail tables

Extremely robust Switch® cocktail tables have an incorporated ball rack and glow-in-the-dark tops.

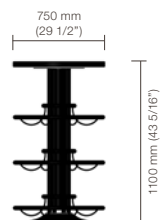

Switch®
Comfort with style

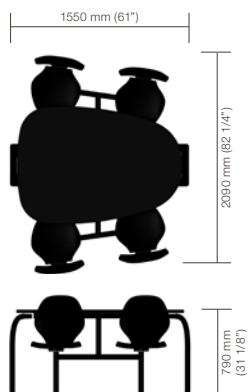

Relax...
Switch®
has you
in mind

Lounge tables (above)
Switch® lounge tables with Pininfarina designed swivel chairs. Large and sturdy, they are ideal for the concourse area, with a shape that offers good visibility toward the centre's action area. The metallic colour version tabletops and seats glow in the dark, thus extending the party atmosphere to the concourse.

Standard tables (below)
Put a spin in your seating. For seating within the bowler's area, Switch® also offers Pininfarina designed tables with swivel chairs. These state-of-the-art tables have glow tabletops and stylish rounded table legs. Switch® engineers designed the sturdy swivel mechanism for long life. The table legs and chairs come in the three colour combinations. The metallic colour version glows in the dark.

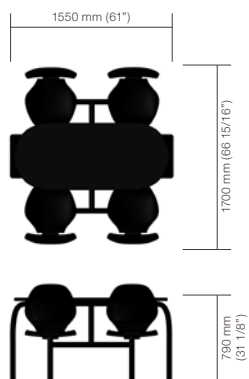



Standard sofas (above)

NEW. Available in the three Switch® colours - red, yellow and metallic - the sofa was designed to provide more comfortable seating for bowlers while waiting their turn. The sofas also help bowlers to feel more relaxed in modern surroundings.

Pininfarina "S" sofas (below)

NEW. Switch® "S" shaped sofas have a striking design and capture the Switch® image through comfort, elegance and style. The "S" sofa is also available as a mirror-image sofa. When the two large, comfortable sofas are fitted together, they occupy no more space than the Switch® standard seating arrangements.



The innovative Chassis has been developed to give total control, both manually and automatically, of every facet of bowling on a pair of lanes.

The composition of the four PC boards in the Chassis works seamlessly to provide many innovative features for both management and maintenance...

Switch®
ST1 Pinsetter

... incorporating the most
advanced technology and latest
safety features.

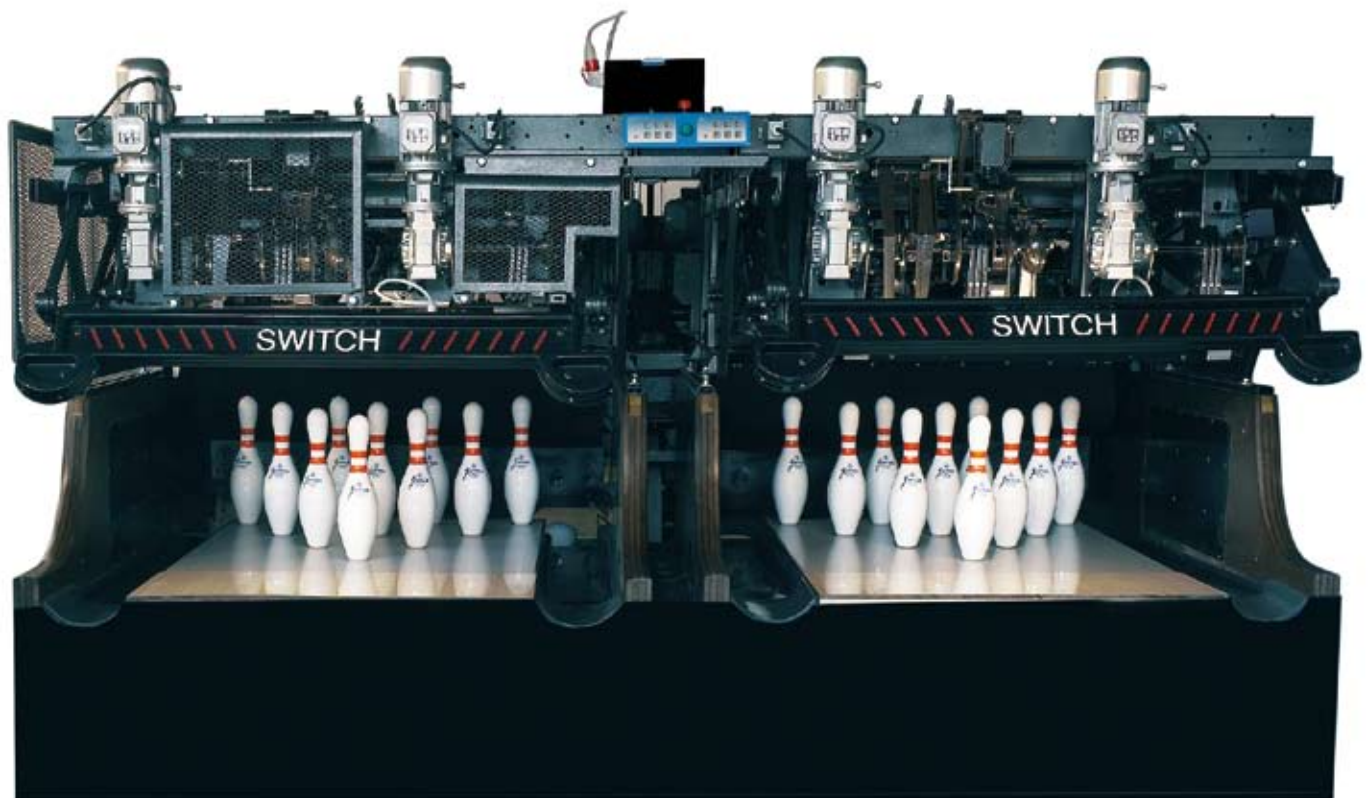

Interfacing with other bowling systems

Every pinsetter command signal has been provided; Pinsetter On/Off, Ball status (1st/2nd ball instant changeover without cycling the pinsetter), cycle start, sweep reverse, short strike cycle, foul cycle, continuous cycle, integrated bumper and glow light control circuits, fully automatic pin sensing (APS) interface, internally/externally polarised inputs.

These features ensure that the Chassis can be interfaced with most scoring systems in the market today.

Pinsetters equipped with motor encoders as well as those with cam switch systems can also be managed by the Chassis.

The inclusion of the innovative CAN bus (Bosch 2.0 standard) system ensures that the control of bowling games on each and every lane benefits from the high levels of reliability, efficiency, speed and security of the information transmitted and received from the Switch® scoring system. Hard wired connections to other scoring systems are also made possible by the comprehensive input/output circuitry provided in the Chassis.

Unlimited future software updates and customisation will be available thanks to the provision of dedicated connectors on the Chassis. Add-ons such as customised safety guards are also simplified due to the ease with which the Chassis can be re-programmed.



Ethernet connection

The Switch® Chassis is also equipped with a web server that provides for the connection of an Ethernet line. This gives total access to all functions including lane administration data, current and energy monitoring, as well as most other data useful to a bowling centre.

The Chassis has a luminous display on the PC board that is visible to the operator through the transparent rear cover. The status of each input and output circuit is constantly displayed to facilitate fault diagnosis and identify the source of any alarm condition. When an anomaly occurs, the LED assigned to the circuit generating the alarm will become red.

Safety measures

The design of the Chassis reflects the commitment of Switch® to the total safety of both bowling centre staff and clientele. The safety measures incorporated in the Switch® Chassis ensure that both regular maintenance and impromptu emergency interventions will be carried out under the safest conditions in the industry.

In the event of an emergency situation, the voltage supply to all motor control circuits in the Chassis are automatically disconnected, preventing both a cycle start from any source and any attempted manual operation of any of the motors in the ST1.

Continuous monitoring

The Chassis also continuously monitors the status of the pinsetter and the position of the Table and Sweep motors. The Chassis will go into alarm mode immediately following the identification of any anomaly in the normal operational sequence of these pinsetter motors. When the anomaly has been identified and rectified, the normal operation of the pinsetter must be restored manually.

The safety of the pinsetter itself is also continuously monitored by sampling the current absorbed by each component part of the ST1. When any value exceeds the preset limit, the Chassis protects itself and the electrical parts connected to it by shutting down into alarm mode.

Energy Efficiency

The Chassis has been developed with particular attention to energy efficiency and the reduction of mechanical wear and tear on the three-phase Table and Sweep motors and gearboxes.

The use of inverters allows the total control of speed and torque, allowing the motors to reach their peak efficiency and at the same time reduce wear and tear to the moving parts driven by them. Electrical values are constantly monitored allowing the sophisticated central control system to intervene immediately when any irregularity is identified.

Switch® masking units and synthetic lanes

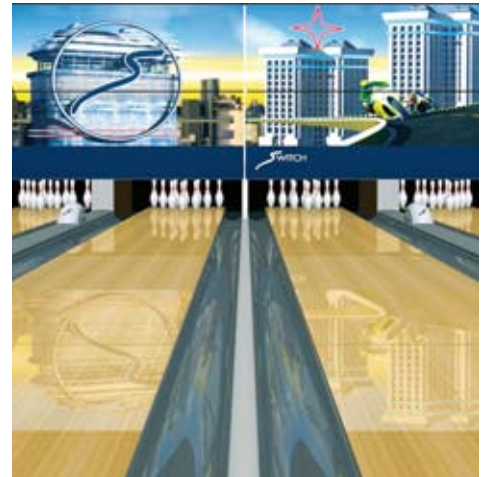

The best
gets even
better

USBC approved Switch® synthetic lanes and pin decks are made by the world-leading laminate manufacturer ABET Laminati in Italy. The lanes are made of a 10 mm thick laminate that complies with EN 438 and ISO 4586 norms. Thickness is achieved using sheets of craft paper impregnated with thermosetting resins.

The resultant panel is then subjected to the combined action of pressure (9MPa) and heat (150°C - 302°F) in special presses in which the resins polycondense. The end result meets the special requirements set by Switch® and USBC, such as self-supporting properties, good dimensional stability and flatness, high-impact resistance, high resistance to wear, high resistance to chemical and organic solvents and excellent resistance to fire.

Non-glow



Matrix

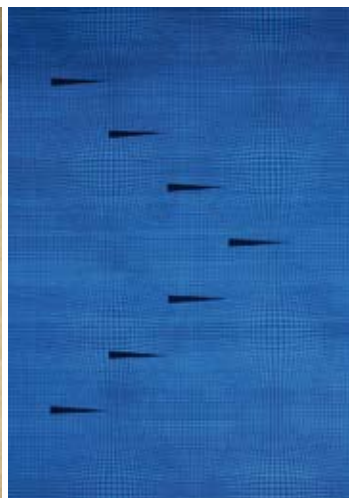

Stargate



Pinstripe



Switch®

Style-setting accessories

Switch® house balls designed by Pininfarina
Switch® urethane house balls designed by Pininfarina are eye-catching and cool with a glow-in-the-dark colour ring. Each weight has its own colour code, which adds to the attractive effect on the lanes.



Switch® standard house balls
Multicoloured urethane standard Switch® house balls. It's easy to choose the right ball because all weights are colour coded.





Bowling pins

The durable bowling pins are made of the finest quality maple wood and feature a nylon injected moulding and a special base ring to prevent fall out. The extremely attractive pins have UV pigment throughout and are resistant to scratching. USBC approved.

Shoes

Switch® 100% leather house shoes are stylish and comfortable. They are available in lace or Velcro versions. The shoe size is embroidered on the back of the shoe, adding to the attractive style.



Full glow carpeting

The Pininfarina 'S' logo decorates the Switch® carpet, in full glow. The carpet is available as an option.



Kegel Crossfire lane machine

The Kegel Crossfire lane machine cleans and conditions a lane in just over one minute. It features an on-board keypad for easy programming, four pre-set programmes for lane play flexibility and three drive speeds. The compact machine uses a spray-jet cleaner application and a fresh cleaning cloth on every lane.



Switch® Distributors

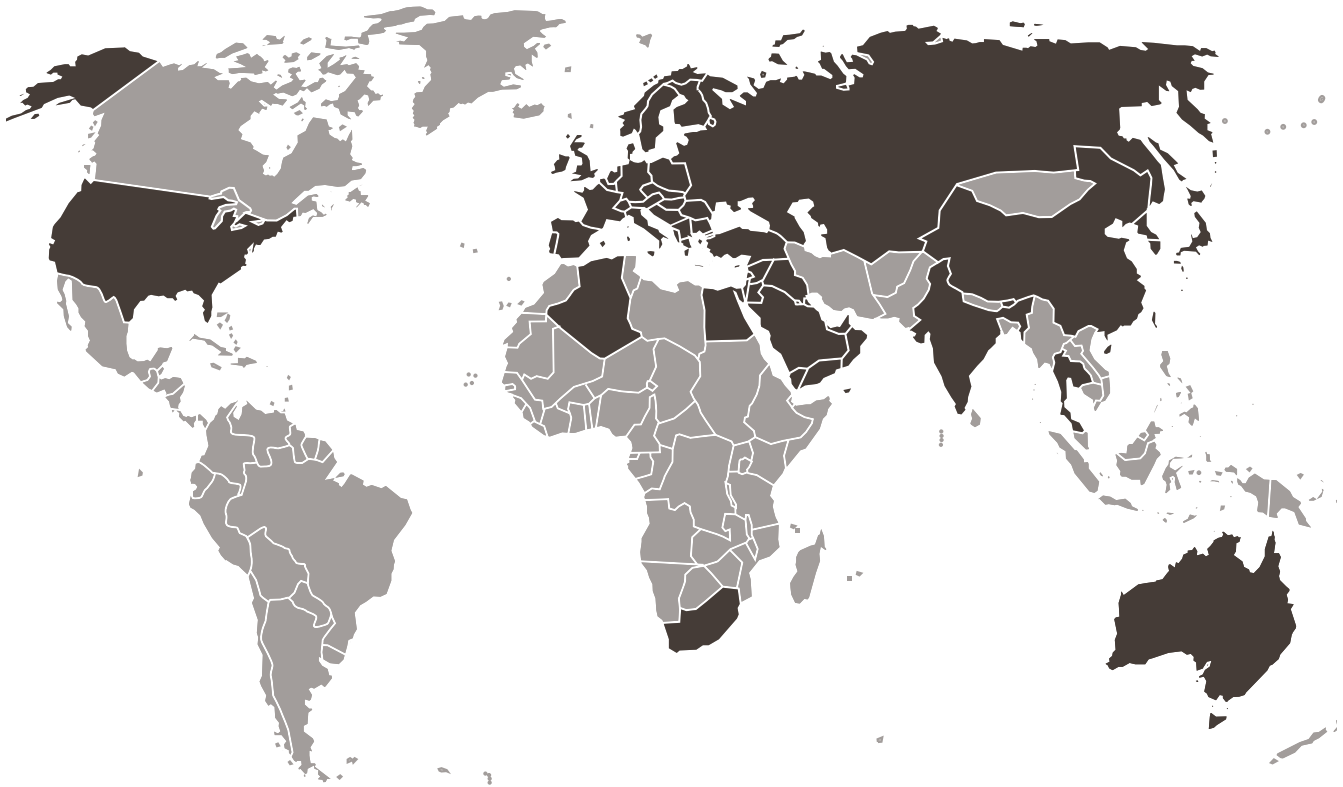

Algeria

Switch Bowling France Sàrl
Mr. Brice Wohlgenuth
p/a Jardins de l'Orangerie
Parc de l'Orangerie
67000 Strasbourg, France
Tel. +33 3 90 41 68 02
Fax +33 3 90 41 68 09
brice@switchbowling.fr
www.switchbowling.fr

Australia

Switch Bowling Asia Pacific Pty Ltd
Mr. Steve Jones
Unit #1 15 Enterprise Crescent
6090 Malaga, Western Australia, Australia
Mob +61 408 152 888
Tel. +61 8 9582 3157
Fax +61 8 9582 3141
steve@switchbowling.com.au
www.switchbowling.com.au

Bulgaria

BG Bowling Ltd.
Mr. Daniel Bondov
2A "Temenuga" Street, Apartment 5
1574 Sofia, Bulgaria
Tel. +359 (28) 739 412
Fax +359 (28) 739 412
Daniel.Bondov@bgbowling.com

China

Switch Bowling Asia
Mr. Stanley Pang
Room 1801, Wing On Central Building
26 Des Voeux Road Central
Central, Hong Kong, China
Tel. [852] 9094-7760
stan@switchbowling.asia
www.switchbowling.asia

Egypt

Switch Middle East
Mr. Ahmed El Komy
6th Floor, BMI Building,
Khalid Bin Walid Street, Bur Dubai, U.A.E.
Tel. + 971 4 352 6222
Fax + 971 4 352 6226
Mob + 971 50 542 2522
ahmedkomy@usa.net

France

Mr. Brice Wohlgenuth
Switch Bowling France Sàrl
p/a Jardins de l'Orangerie
Parc de l'Orangerie
67000 Strasbourg, France
Tel. +33 3 90 41 68 02
Fax +33 3 90 41 68 09
brice@switchbowling.fr
www.switchbowling.fr

Germany

Sabim Deutschland GmbH
Mr. Manfred Hill
Industriegebiet 9
55606 Hochstetten-Dhaun, Germany
Tel. +49 6752 913870
Fax +49 6752 913872
info@sabim-deutschland.de
www.sabim.de

Hong Kong

Switch Bowling Asia
Mr. Stanley Pang
Room 1801, Wing On Central Building
26 Des Voeux Road Central
Central, Hong Kong, China
Tel. [852] 9094-7760
stan@switchbowling.asia
www.switchbowling.asia

Indonesia

Switch Bowling Asia Pacific Pty Ltd.
Mr. Steve Jones
Unit #1 15 Enterprise Crescent
6090 Malaga, Western Australia, Australia
Mob. +61 408 152 888
Tel. +61 8 9582 3157
Fax +61 8 9582 3141
steve@switchbowling.com.au
www.switchbowling.com.au

Ireland

Switch Bowling UK Ltd
Mr. Terry Fawdington
Gildor House
West Street
LE19 7EJ Earl Shilton / Leicestershire
United Kingdom
Mob. +44 7802221021
Tel. +44 (1455) 851010
Fax +44 (1455) 851777
terryfawdington@bowlinginternational.com
www.switchbowling.co.uk

Italy

Sabim Bowling Marketing Service S.p.a.
Mr. Mario Silvestri
Via Degli Scarlatti 63
41100 Modena, Italy
Tel. +39 059 280 556
Fax +39 059 280 761
info@sabim.it
www.sabim.it

Japan

Mr. Hiroshi Kobayashi
HI-SPORTS co., LTD
2-15-14 Meguro
Meguro-KU
153-0063 Tokyo, Japan
Tel. +91 (0)3 3791 6871
Fax +91 (0)3 3719 1918
h.kobayashi@hi-sp.co.jp

Macao

Switch Bowling Asia
Mr. Stanley Pang
Room 1801, Wing On Central Building
26 Des Voeux Road Central
Central, Hong Kong, China
Tel. [852] 9094-7760
stan@switchbowling.asia
www.switchbowling.asia

Middle East

Switch Middle East
Mr. Ahmed El Komy
6th Floor, BMI Building,
Khalid Bin Walid Street, Bur Dubai, U.A.E.
Mob. + 971 50 542 2522
Tel. + 971 4 352 6222
Fax + 971 4 352 6226
ahmedkomy@usa.net

New Zealand

Switch Bowling Asia Pacific Pty Ltd.
Mr. Steve Jones
Unit #1 15 Enterprise Crescent
6090 Malaga, Western Australia, Australia
Mob. +61 408 152 888
Tel. +61 8 9582 3157
Fax +61 8 9582 3141
steve@switchbowling.com.au
www.switchbowling.com.au

Philippines

Switch Bowling Asia Pacific Pty Ltd.
Mr. Steve Jones
Unit #1 15 Enterprise Crescent
6090 Malaga, Western Australia, Australia
Mob +61 408 152 888
Tel. +61 8 9582 3157
Fax +61 8 9582 3141
steve@switchbowling.com.au
www.switchbowling.com.au

Romania

SC Ischia S.R.L.
Ms. Elena G. Hincu
George Cosbuc Nr 17 – M2/114
800357 Galati Romania
Mob. +40 744 37 27 43
Tel. +40 236 47 55 59
Fax +40 236 47 55 59
rm@ischiasport.ro
www.ischiasport.ro

Russia

Switch Bowling Russia Inc.
Mr. Arkadiy Surenyan
Kastanaevskia street d.16, kop.1
121096 Moscow, Russia
Tel. +7(495)228-78-49
Fax +7(495)739-59-98
info@switchbowling.ru
www.switchbowling.ru

Saudi Arabia

Mabrook J. Al Mabrook Est. for Trade & Service
Mr. Harris Osman
Behind Eastern Governorate, Dhahran Road
P.O. Box 60422, 31545 Dammam, Saudi Arabia
Mob. +966 535 411 123
Tel. +966 3 833 34 76
Fax +966 3 833 38 74
almabrookest@yahoo.com
www.almabrookest.com

Singapore

MARINE BOWL,
Mr. Amas
1000 East Coast Parkway
Marine Cove, 449876 Singapore
Mob. +65 9011-5515
Tel. +65 6442-0400
Fax +65 6443-0400
mbowl@singnet.com.sg

Spain

Sabim Bowling Espana S.L.
Mr. Emilio Ros-Peréz
Avda de Emperatriz Isabel,
5 Bajos
28019 Madrid, Spain
Mob. +34670791612
Tel. +34 91 460 0040
Fax +34 91 569 0627
sabimespana@telefonica.net

Thailand

Green Medicarx Co., Ltd.
Mr. Isra Vibhatavanija
169 Soi Pattanakarn
40 Suanloun
10250 Bangkok, Thailand
Tel. +66 2 722 6985
Fax +66 2 722 7980
visra@mozart.inet.co.th

Turkey

Helis Spor Ltd.
Mr. Ahmet Solmaz
Uskumruköy Mah. Kilyos Yolu Cad.
Demirciköy Sapa ı, Villa A12
34427 Sanyer – Istanbul / Turkey
Mob. +90 532 2313738
Tel. +90 212 2015698
Fax +90 212 2015699
asolmaz@switchbowling.net
www.switchbowling.net

Ukraine

Switch Ukraine Inc.
Mr. Oleg Olkhovoyi
Corso Pobedy 84
Bowling Club «Strike»
03190 Kiev, Ukraina
Tel. +380 (44) 501 01 10
Fax +380 (44) 501 01 10
prosport@strike.kiev.ua

United Kingdom

Switch Bowling UK Ltd
Mr. Terry Fawdington
Gildor House, West Street
LE19 7EJ Earl Shilton / Leicestershire
United Kingdom
Tel. +44 (1455) 851010
Fax +44 (1455) 851777
Mob. +44 7802221021
terryfawdington@bowlinginternational.com
www.switchbowling.co.uk

USA & Canada

Switch Bowling & Billiards LLC
Mr. James Borin
1025a Avenue M
Grand Prairie, 75050 TX
United States of America
Tel. +001 9726794824
james@switchbowling.com
www.switchbowling.com

Switch Entertainment S.A.
Rue César-Soulié 5
1260 Nyon, Switzerland
Tel. +41 (0) 22 365 18 80
Fax. +41 (0) 22 365 18 85
info@switchbowling.com

Switch Logistics S.r.l.
Via Peri, 71
41100 Modena, Italy
Tel. +39 (059) 284838
Fax. +39 (059) 284838
logistics@switchbowling.com

Switch Electronics S.r.l.
Via Peri, 71
41100 Modena, Italy
Tel. +39 (059) 284838
Fax. +39 (059) 284838
electronics@switchbowling.com

Switch Bowling & Billiards LLC
1025a Avenue M
Grand Prairie, 75050 TX
United States of America
Tel. +001 9726794824
james@switchbowling.com



www.switchbowling.com